

EMISSION SOLUTIONS & FLEX HOSE





- Replacement for OE 2007+ bellows type section. All Stainless steel construction. Twist and stretch movement out performs the OE!



- A NEW generation of multiply stainless flex that gives you LEAK FREE performance with torsional movement! Stainless flex out performs bellows.



- Marmon flanges are available for 2.5" thru 5" diameter. Parts can be welded to any part we have for a 100% leak free joint. 2007 + emission exhaust standard.

EMISSIONS SOLUTIONS

BELLOWS, UNIVERSAL HEAT SHIELDS & APU

BELLOWS

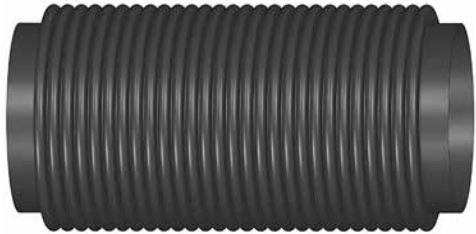

Bellows:

- Single Ply 304 Stainless
- Diameter, length, and part no. can be found in the flex hose section on page 77

UNIVERSAL HEAT SHIELDS

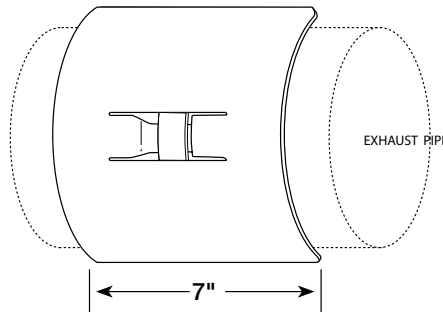

- Keep wiring, air, and hydraulic lines away from hot exhaust pipes
- Works on 3"- 6" diameter pipes

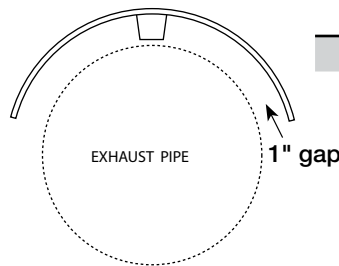

PART#	QTY.
UHS	1 Per Box
UHS-B	10 Per Box

UNIVERSAL HEAT SHIELDS:

- Heat shield for exhaust pipe
- Protect wires, air, oil or fuel lines from extreme heat
- Universal fit, any diameter pipe
- Held on with strap clamp (included)

APU

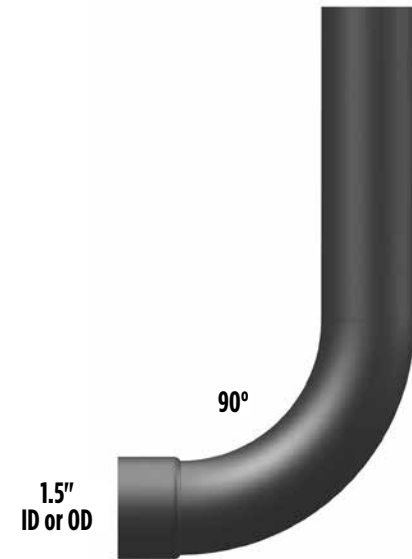

APU or auxiliary heaters on your truck or bus and need to get the exhaust out? We bend 1.5" diameter for these exhaust pipes. Call or send prints.

EMISSIONS SOLUTIONS HEAT SLEEVES & WRAPS

Either the heat sleeve or the heat wrap will reduce the outside temperature of a bare pipe by 300° F to 400° F

HEAT SLEEVES

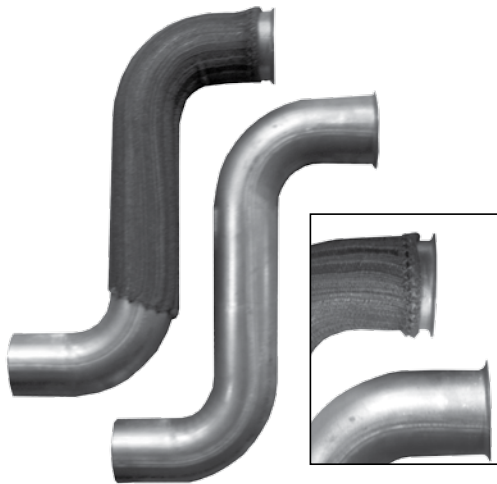

Slips onto 3" to 5" dia. pipe

PART NO.	LENGTH
HS-12	12"
HS-18	18"
HS-24	24"

HEAT WRAPS

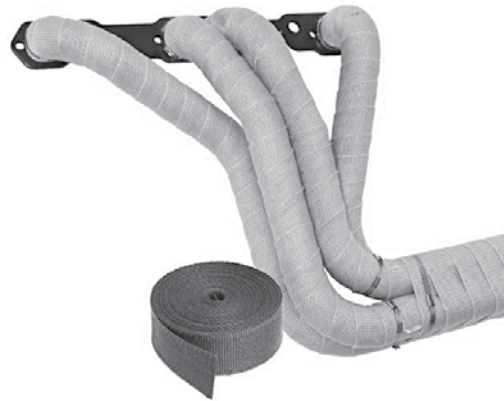

Simple 2" wide roll, easy to install on any pipe

PART NO.	LENGTH
HW-2600	2" x 50' (600") roll

HEAT SLEEVE & WRAP CLAMPS



Wrap clamps make installation easy!
No tools needed.

PART NO.	LENGTH
HC-18SS	2 pc of 18" long clamp
HC-18SSB	12 pc of 18" long clamp

EMISSIONS SOLUTIONS FLEX HOSE, MARMON FLANGES & FLARES

FLEX HOSE

NEW generation of leak resistant stainless flex that works well on the 2007+ engines. Has both great torsional and length movement. Diameter and length part numbers are on pgs. 78 & 79 in the flex hose section.



TYPE SSS (33% THICKER) 4 PLY
• SPECIAL INTERLOCKED PROFILE •

MARON FLANGE & FLARES

These are used to join parts together for leakproof and serviceable connections with a VBand Clamp all 304SS.



TUBE DIAMETER	FLARE PART NO.	V BAND CLAMP PART NO.	FLANGE PART NO.
2.5"	39659-l	VB-300c	42315-l
4"	39660-l	vb-475c	41967-l
5"	39392-l	vb-588c	41968-l

EMISSIONS SOLUTIONS CERAMIC LINES AND/OR COATED

CL - Ceramic Lined

We can add ceramic lining to a CHROME pipe. Use our high quality chrome parts on your 2007+ truck.

CC - Ceramic Coated

Coats the exterior of any part for a true Thermal Barrier. Keeps hot temperatures INSIDE the pipe to help with emissions and keeps cab floors, wires, & hoses cool

CL/CC - Ceramic Lined AND Ceramic Coated

Line and Coat pipe for the Ultimate in Thermal Barrier.

Call for Price and Availability, plus more details

FLEX HOSE

FLEX HOSE OPTIONS

- Premium Triple S Stainless Steel (304 non magnetic) 4 PLY (BEST)
- 304 Stainless Conventional Flex (non magnetic) (BETTER)
- 409 Stainless Conventional Flex (magnetic) (GOOD)
- Galvanized Conventional Flex
 - .018 Thick Strip (magnetic) (GOOD)
- Galvanized Conventional Flex
 - .015 Thick Strip (magnetic) (GOOD)
- Bellows, Single Ply
 - 304 Stainless (non magnetic) will not twist

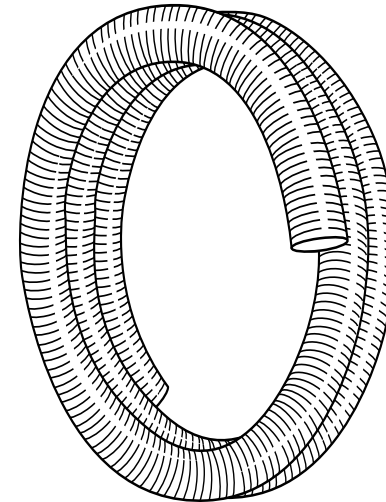

FLEX HOSE 4" & 5" STAINLESS FLEX USER GUIDE

RATING = GOOD (Type 409 Stainless - Magnetic)

- Better corrosion resistance than Galvanized or Aluminized Flex
- Flexibility = STIFF, can be cut and trimmed

PART NO. 4" DIA/LENGTH

S49-4300	4" x 25' Roll
S49-4120	4" x 10' Roll
S49-418	4" x 18" Precut
S49-424	4" x 24" Precut
S49-436	4" x 36" Precut

PART NO. 5" DIA/LENGTH

S49-5300	5" x 25' Roll
S49-5120	5" x 10' Roll
S49-512	5" x 12" Precut
S49-518	5" x 18" Precut
S49-524	5" x 24" Precut
S49-536	5" x 36" Precut



RATING = BETTER (Type 304 Stainless - Non-Magnetic)

- Better quality stainless flex material — WILL NOT RUST OR CORRODE
- Flexibility on 10' & 25' Rolls = STIFF (typical), can be cut and trimmed
- Flexibility on 12" thru 48" Precuts = VERY FLEXIBLE, can be cut and trimmed

PART NO. 4" DIA/LENGTH

SF-4300	4" x 25' Roll
SF-4120	4" x 10' Roll
SF-412	4" x 12" Precut
SF-418	4" x 18" Precut
SF-424	4" x 24" Precut
SF-436	4" x 36" Precut
SF-448	4" x 48" Precut

PART NO. 5" DIA/LENGTH

SF-5300	5" x 25' Roll
SF-5120	5" x 10' Roll
SF-512	5" x 12" Precut
SF-518	5" x 18" Precut
SF-524	5" x 24" Precut
SF-536	5" x 36" Precut
SF-548	5" x 48" Precut



(Conventional Interlocked Profile)

RATING = BEST (OE Type SSS 304 Stainless - Non-Magnetic)

- Best quality stainless flex type — WILL NOT RUST OR CORRODE
- Precuts Only - Featuring EXTENSION GAUGE STRAP & Individually Boxed!
- SUPER FLEXIBLE & Torsional Movement, DO NOT cut or trim

PART NO. 4" DIA/LENGTH

WFF-412	4" x 12" Precut
WFF-415	4" x 15" Precut
WFF-418	4" x 18" Precut
WFF-424	4" x 24" Precut

PART NO. 5" DIA/LENGTH

WFF-512	5" x 12" Precut
WFF-515	5" x 15" Precut
WFF-518	5" x 18" Precut
WFF-521	5" x 21" Precut
WFF-524	5" x 24" Precut

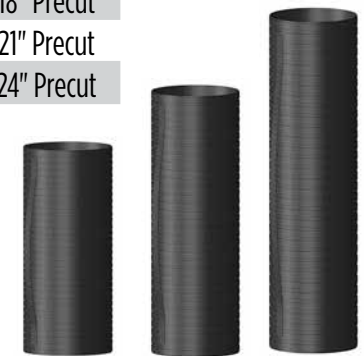

TYPE SSS (33% THICKER)
• SPECIAL INTERLOCKED PROFILE •

FLEX HOSE FLEXIBLE METAL HOSE

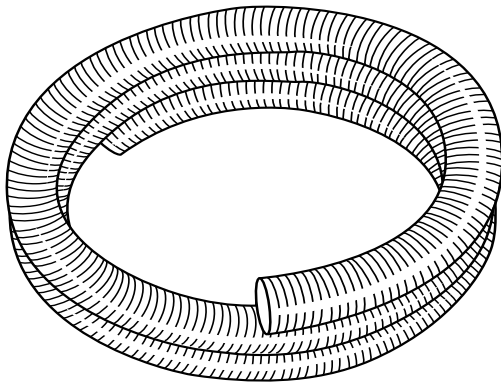

10' and 25' COILS

DIA.	STD. DUTY GALVANIZED 25' ROLL	STD. DUTY GALVANIZED 10' ROLL	HEAVY DUTY GALVANIZED 25' ROLL	HEAVY DUTY 304 STAINLESS 10' ROLL	HEAVY DUTY 304 STAINLESS 25' ROLL
1.5"	—	—	—	—	SF-15300
2"	G15-2300	—	—	—	—
2.5"	G15-25300	G15-25120	—	—	SF-25300
2.75"	G15-275300	—	—	—	SF-275300
3"	G15-3300	G15-3120	—	SF-3120	SF-3300
3.5"	G15-35300	G15-35120	—	SF-35120	SF-35300
4"	G15-4300	G15-4120	G18-4300	SF-4120	SF-4300
5"	G15-5300	G15-5120	G18-5300	SF-5120	SF-5300
6"	—	G15-6120	—	SF-6120	SF-6300
7"	—	—	—	SF-7120	—

PRECUT LENGTHS

Various Pre-Cut Lengths:

- Deburred Ends
- Save the Time and Hassle of Cutting
- Easier to Inventory and Handle
- Easier to Display

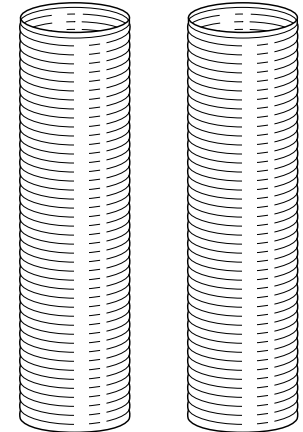

NOTE: All Grand Rock Flex is measured in RELAXED lengths.
• Compression may occur during handling and transit

DIA.	LENGTH	GALVANIZED	409 STAINLESS	HEAVY DUTY 304 STAINLESS
3"	24"	—	—	SF-324
3"	36"	—	—	SF-336
3.5"	12"	G15-3512	—	—
3.5"	18"	—	—	SF-3518
3.5"	24"	G15-3524	—	SF-3524
3.5"	36"	G15-3536	—	SF-3536
4"	12"	G15-412	S49-412	SF-412
4"	18"	G15-418	S49-418	SF-418
4"	24"	G15-424	S49-424	SF-424
4"	36"	G15-436	S49-436	SF-436
4"	48"	G15-448	—	SF-448
5"	12"	G15-512	S49-512	SF-512
5"	18"	G15-518	S49-518	SF-518
5"	24"	G15-524	S49-524	SF-524
5"	36"	G15-536	S49-536	SF-536
5"	48"	G15-548	—	SF-548

